



HSM Baling Press Systems

Waste disposal solutions for all application areas

We like to do things differently: namely better.

HSM baling presses are the specialist solution for compressing waste materials by up to 95 % into sorted, easily transportable bales. The product portfolio ranges from vertical and horizontal presses for the retail industry and manufacturers to shredder baler systems, PET/UBC

compaction technology and fully automatic baling press systems for professional waste disposal companies. Regardless of the material, the volume or the location – HSM has the product you need.



**Up to 95 %
volumen reduction**



Vertical Baling Presses



Horizontal Baling Presses



PET-Systems



Multilevel Shredder-Systems

Welcome to the update from HSM – and what stands behind it: our People. Because even though the highest quality, reliable service and innovative product ideas have made us into one of the market leaders for baling presses, it is the minds, ideas and input of our entire team which are always behind them for our customers. You can find out more about us and the key differences that

make up an HSM baler in the next few pages. So get to know us and send us your request! You can rest assured: you'll always get more than just a baling press!

More Quality. More Service. More Possibilities.



Partnership

Our competent team will accompany you as partners in all phases, and all around the world. From consulting and project planning, to delivery and assembly, all the way to customer service.



Solutions to match your requirements

We can provide comprehensive on-site advice. Experienced specialists from our sales and project teams can determine the optimum solution for your requirements.



Reliability

Whichever solution you decide upon, you will always choose innovative, reliable and highly efficient technology "Made in Germany" with HSM.



Service

Our service experts will accompany you from in-stallation, training and initial start-up, to service and maintenance for smooth and efficient operation.

We are your partner – for products and project planning!



HSM does not just offer hardware alone, but provides individual system solutions as well.

When it comes to demanding systems, you can benefit from our extensive know-how and broad experience. Experienced HSM specialists assist you right from the start on-site and provide ongoing support and service.

With the wide range of options and accessories, our disposal solution can be fully integrated into your existing operations and processes. The individualised design makes the entire system efficient.

Examples of compressible materials

- 1 Plastic film
- 2 Cardboard
- 3 Paper
- 4 PET bottles
- 5 Plastics [PP: Polypropylen]
- 6 Plastics [PVC: Polyvinylchlorid]
- 7 Plastics [HDPE: High-density polyethylene]
- 8 Plastics [LDPE: Low-density polyethylene]

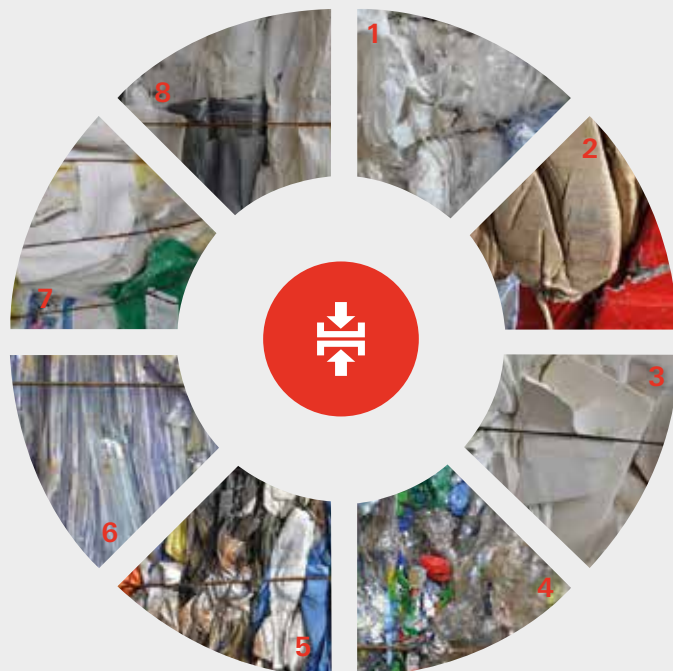

Up to 95 %
volume reduction

Our reference customers

HSM machines are suitable for (virtually) any task – worldwide.

Models and solutions from a wide of product areas are used to achieve this result. See for yourself how HSM baling presses and HSM document shredders prove themselves in daily use in the following examples. On request, we would be glad to provide you with reference addresses for your applications.



RÜDIGER GRAF

Operations Manager, Smurfit Kappa, Neuburg an der Donau

The under-utilisation of the lorries is now finally a thing of the past for us.



HANS-PETER KREMER

Technical Developer, Thommen AG

According to our thorough market observation, we see that the machine from HSM is unbeatable in terms of robustness, efficiency and reliability.



Amongst all of the advantages, there is one decisive plus point exists: HSM Service.

We deliver quality and are also responsible for this after the sale. We take service seriously, and are committed to helping our customers in the best way

possible. This not only applies to our headquarters but also to all HSM service centres in Germany and all over the world.



Organisation of logistics services

- Transport organisation, co-ordination of other partners
- Installation, instructions and start-up
- Maintenance, servicing and upkeep
- Maintenance contracts



On-site expert advice

- On-site specialist advice from experienced consultants in the sales and project teams
- Calculation of cost savings by using an HSM baling press in comparison with the current disposal solution
- Review and formulation of the individual tasks and requirements
- Arranging meetings between the customer, field service and project team
- Implementation of special solutions
- Project drawings



Service by trained engineers

- Approx. 65 field service technicians and 15 office service technicians in Germany, Austria, Switzerland, Belgium, the Netherlands and Italy
- Approx. 35 field service technicians and 10 office service technicians in the subsidiaries (England, France, Poland, Spain, USA and China)
- Partner companies in more than 100 countries



Training sessions by the HSM Academy

Service training for engineers and operators on-site or in the HSM training centre by the HSM Academy.

Using HSM machines means reducing CO₂ emissions

HSM originated from the idea to reduce the volume of residual materials through pressing, and returning these newly recovered valuable products to the production cycle. Since the company was founded in 1971, sustainability has been our core business and a matter of course. When designing and constructing our presses, we focus on the responsible use of resources. HSM presses thus retain their value over a particularly long life span and

operate extremely energy-efficiently. The bale dimensions and weights of HSM baling presses are designed to allow optimum utilisation of truck capacities. And transporting less air saves expensive and environmentally damaging transport routes. The frequency-controlled drives make an even greater contribution to environmental protection and the economic efficiency of the presses. This saves up to 40 % electricity compared to a conventional drive.



No use of composite materials guarantees 100 % product recycling



Use of only environmentally compatible, recyclable auxiliary and operating materials



Use of low-solvent lacquers



Recycling of metal production waste



Use of photovoltaics to generate electricity for production



Use of heat recovery in production



Short transport routes due to production in Germany

HSM quality „Made in Germany“

HSM has always committed itself to the principle of “Quality”. HSM relies on Germany as a production location and quality products “Made in Germany”. All three German HSM plants are certified under DIN EN ISO 9001. Since we manufacture our products ourselves, we can guarantee first-class quality. The

large vertical range of manufacture is characteristic of HSM and brings decisive advantages. Production can thus be controlled reliably, flexibly and independently. But it also allows us to control the origin, quality and ingredients of the raw materials and other materials used.



HSM AK 807

For industrial applications with small material loads



HSM AK 807

- Suitable for continuous loading
- Variety of uses
- Operating side can be selected
- Compact bale dimensions
- Low space requirement
- Approved system solution and technology
- Control of compression cycle via light barrier



Processing industry



Department stores



Document shredding facilities



Others



Throughput up to approx.
36 m³/h

HSM AK 807

- Continuous feeding baling press
- Manual strapping
- Low price, reliable
- Especially suitable for air feed connection
- Mainly presses cardboard and light paper

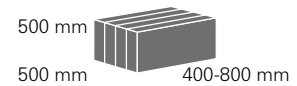

Model	HSM AK 807
Pressing power	82 kN
Volume throughput	up to approx. 0.72 t / h with 20 kg/m ³
Bulk weight	up to approx. 20 kg/m ³
Bale weight (depending on material)	up to approx. 60 kg
Cycle time	approx. 17.6 s / cycle
Strapping (manual)	3-fold horizontal with polyester tape

All technical data and dimensions are approximate values. Measurements in mm. Technical and design modifications reserved.

HSM VK 807 V, VK 1206, VK 1210, VK 2306, VK 2310

For industrial applications with small to medium material loads



HSM VK 2310

- Suitable for continuous loading
- Variety of uses
- Suitable for many different materials
- Operating side can be selected
- Control of compression cycle via light barrier
- Compact bale dimensions
- Low space requirement
- Available as an option with manual strapping



**Processing
industry**



**PET bottles
disposal**



**Document shredding
facilities**



**Printing and paper
industry**



Throughput up to approx.
28 m³/h

HSM VK 807 V

- The smallest fully-automatic baling press
- Particularly suitable for cardboard, films and paper edge trims
- Compact design
- Fully automatic vertical strapping
- Optimal for integration in assembly line

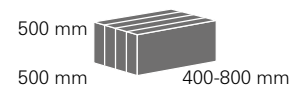

Model	HSM VK 807 V
Pressing power	82 kN
Pressleistung	up to approx. 0.55 t / h with 20 kg/m ³
Bulk weight	up to approx. 20 kg/m ³
Bale weight (depending on material)	up to approx. 60 kg
Cycle time	approx. 23.2 s / cycle
Strapping (manual)	2-fold vertical with wire

All technical data and dimensions are approximate values. Measurements in mm. Technical and design modifications reserved.



Throughput up to approx.
117 m³/h

HSM VK 1206

- Tried and tested for years, reliable and with multiple uses
- Particularly suitable for cardboard, plastic film and PET bottles
- Optimal for connecting to air feeding systems (fast cycle times) – 600 mm loading aperture
- Available as an option with manual strapping
- Suitable for a combination with a HSM Duo /- or Trishredder



HSM VK 1210

- Similar to HSM VK 1206, with larger loading length
- Particularly suitable for cardboard, plastic film and PET bottles
- Available as an option with manual strapping
- Loading aperture of 1000 mm suitable for larger material pieces and higher throughput rates
- Suitable for a combination with a HSM Duo /- or Trishredder

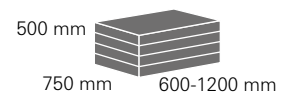

Model	HSM VK 1206	HSM VK 1210
Pressing power	160 kN	160 kN
Volume throughput	up to approx. 1.97 t / h with 20 kg/m ³	up to approx. 2.35 t / h with 20 kg/m ³
Bulk weight	up to approx. 40 kg/m ³	up to approx. 40 kg/m ³
Bale weight (depending on material)	up to approx. 200 kg	up to approx. 200 kg
Cycle time	approx. 8.2 s / cycle	approx. 11.5 s / cycle
Strapping (fully automatic)	3-fold horizontal with wire	3-fold horizontal with wire

All technical data and dimensions are approximate values. Measurements in mm. Technical and design modifications reserved.



Throughput up to approx.
144 m³/h

HSM VK 2306

- Similar to HSM VK 12 series, with higher pressing power
- High bale density, high bale weights, high shearing forces
- Compresses paper, cardboard, plastic film, Paper shred trims, shredded material and PET bottles
- Particularly suitable for PET compaction and for special applications
- Suitable for a combination with a HSM Duo /- or Trishredder



HSM VK 2310

- Similar to HSM VK 12 series, with higher pressing power
- High bale density, high bale weights, high shearing forces
- Compresses paper, cardboard, plastic film and PET bottles
- Loading aperture of 1000 mm suitable for larger material pieces and higher throughput rates
- Suitable for a combination with a HSM Duo /- or Trishredder

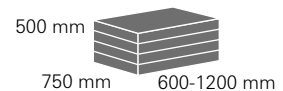

Model	HSM VK 2306	HSM VK 2310
Pressing power	240 kN	240 kN
Volume throughput	up to approx. 6.03 t / h with 50 kg/m ³	up to approx. 7.18 t / h with 50 kg/m ³
Bulk weight	up to approx. 50 kg/m ³	up to approx. 50 kg/m ³
Bale weight (depending on material)	up to approx. 250 kg	up to approx. 250 kg
Cycle time	approx. 6.7-12.3 s / cycle	approx. 9.4-17.2 s / cycle
Strapping (fully automatic)	3-fold horizontal with wire	3-fold horizontal with wire

All technical data and dimensions are approximate values. Measurements in mm. Technical and design modifications reserved.

HSM VK 3008, VK 3012, VK 4208, VK 4212, VK 4812, VK 4812 V, VK 4812 P

For industrial applications with medium material loads



HSM VK 4812 V

- Throughput up to approx. 16.6 tons per hour
- Suitable for continuous loading with conveyor belt, air feeding or similar
- Suitable for different materials with bulk weights up to 60 kg/m³
- Operating side can be selected
- Versatile use, also suitable for special materials (on request)
- Control of compression cycle via light barrier
- High compression and bale weights
- Integration into automated industrial production processes



Processing industry



Department store



Document shredding industry



Printing and Paper industry



Others



Throughput up to approx.
228 m³/h

HSM VK 3008 / HSM VK 3012

- Versatile solution for materials up to approx. 50 kg/m³ bulk weight
- Particularly suitable for compression of paper, cardboard and plastic film
- HSM VK 3008 for fast cycle times, 800 mm loading aperture
- HSM VK 3012 with large loading aperture (1140 mm length)

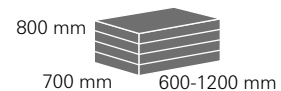

Model	HSM VK 3008 / HSM VK 3012
Pressing power	310 kN
Volume throughput	up to approx. 11.4 t / h with 50 kg/m ³
Bulk weight	up to approx. 50 kg/m ³
Bale weight (depending on material)	up to approx. 350 kg
Cycle time	approx. 8.2-13.9 s / cycle
Strapping (fully automatic)	4-fold horizontal with wire

All technical data and dimensions are approximate values. Measurements in mm. Technical and design modifications reserved.



Throughput up to approx.
251 m³/h

HSM VK 4208 / HSM VK 4212

- Versatile solution for materials up to approx. 60 kg/m³ bulk weight
- Suitable for compressing paper, cardboard, shredded material and plastic film
- HSM VK 4208 for fast cycle times, 800 mm loading aperture
- HSM VK 4212 with large loading aperture for optimised feeding methods (1140 mm length)

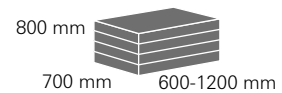

Model	HSM VK 4208 / HSM VK 4212
Pressing power	420 kN
Volume throughput	up to approx. 12.5 t / h with 50 kg/m ³
Bulk weight	up to approx. 60 kg/m ³
Bale weight (depending on material)	up to approx. 420 kg
Cycle time	approx. 7.5-17.4 s / cycle
Strapping (fully automatic)	4-fold horizontal with wire

All technical data and dimensions are approximate values. Measurements in mm. Technical and design modifications reserved.



Throughput up to approx.
332 m³/h

HSM VK 4812

- For materials up to approx. 60 kg/m³ bulk weight
- Particularly suitable for compression of cardboard and plastic film
- With large loading aperture and higher pressing power
- Large bales and high bale weights

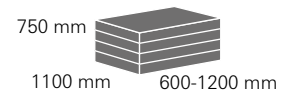

Model	HSM VK 4812
Pressing power	480 kN
Volume throughput	up to approx. 16.6 t / h with 50 kg/m ³
Bulk weight	up to approx. 60 kg/m ³
Bale weight (depending on material)	up to approx. 450 kg
Cycle time	approx. 11.2-21.2 s / cycle
Strapping (fully automatic)	4-fold horizontal with wire

All technical data and dimensions are approximate values. Measurements in mm. Technical and design modifications reserved.



Throughput up to approx.
204 m³/h

HSM VK 4812 V

- For materials up to approx. 60 kg/m³ bulk weight
- Very low space requirement
- Especially large loading aperture for bulky materials
- High compression and bale weights
- Excellent price/performance ratio
- Fully automatic vertical strapping



HSM VK 4812 P

- For materials up to approx. 60 kg/m³ bulk weight
- Particularly suitable for compression of PET bottles
- Tandem connection of the main pressing cylinders for an extra compact design
- High compression and bale weights
- Excellent price/performance ratio

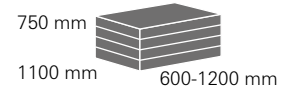

Model	HSM VK 4812 V	HSM VK 4812 P
Pressing power	480 kN	480 kN
Volume throughput	up to approx. 10.2 t / h with 50 kg/m ³	up to approx. 10.2 t / h with 50 kg/m ³
Bulk weight	up to approx. 60 kg/m ³	up to approx. 60 kg/m ³
Bale weight (depending on material)	up to approx. 450 kg	up to approx. 450 kg
Cycle time	approx. 18.2-24.5 s / cycle	approx. 18.2-24.5 s / cycle
Strapping (fully automatic)	4-fold vertical with wire	4-fold horizontal with wire

All technical data and dimensions are approximate values. Measurements in mm. Technical and design modifications reserved.

HSM VK 4012

For industrial applications with special requirements



HSM VK 4012

- Throughput up to approx. 12 tons per hour
- Operating side can be selected
- Control of compression cycle via light barrier
- Suitable for materials with bulk weights up to approx. 40 kg/m³
- For continuous loading with conveyor belt or for manual feeding
- High compression and bale weights
- Suitable for integrating into automated production and disposal processes (e.g. central storage areas, distribution centres etc.)



Processing industry



Department store



Others



Throughput up to approx.
239 m³/h

HSM VK 4012

- Versatile solution for materials up to approx. 40 kg/m³ bulk weight
- Particularly suitable for compressing lighter packaging materials, such as cardboard and plastic film
- Compact, space-saving design
- Large loading aperture

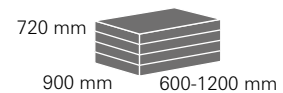

Model	HSM VK 4012
Pressing power	450 kN
Volume throughput	up to approx. 11.97 t / h with 50 kg/m ³
Bulk weight	up to approx. 40 kg/m ³
Bale weight (depending on material)	up to approx. 400 kg
Cycle time	approx. 12.2-16.7 s / cycle
Strapping (fully automatic)	3-fold horizontal with wire

All technical data and dimensions are approximate values. Measurements in mm. Technical and design modifications reserved.

HSM VK 5012, VK 6215, VK 7215

For professional disposal management or larger industrial applications – with high throughput rates



HSM VK 5012

- 5-fold strapping for optimised bale result
- Particularly suitable for cardboard, paper and plastic film and also for compressing DSD goods and PET bottles
- Also suitable for materials with bulk weights higher than 60 kg/m^3
- Optimised bale dimensions and bale weights for efficient truck loading
- Large loading aperture, quick mode of operation
- Control of compression cycle via light barriers
- High compression and bale weights
- Available as an option with frequency controlled drive – saves 40 % of the energy used by standard drives



Processing industry



Department store



Document shredding industry



Printing- and Paper industry



PET bottles/ USB disposal



Disposal companies



Others



Throughput up to approx.
485m³/h

HSM VK 5012 / HSM VK 5016

- Suitable for cardboard, plastic film and compressing DSD goods, as well as PET bottles (other materials on request)
- Optimised bale dimensions and bale weights for efficient truck loading
- Large loading aperture suitable for bulky material
- Programmable Siemens logic controller with touch panel
- Optimally adjusted software for different materials guarantees high bale quality even when material is frequently changed
- Solid steel construction with highly wear resistant steel parts inside the press chamber and press channel
- Easy access to all servicing parts due to large inspection doors

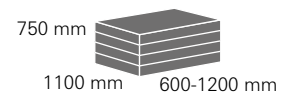

Model	HSM VK 5012 / HSM VK 5016
Pressing power	500 kN
Volume throughput	up to approx. 24.25 t / h with 50 kg/m ³
Bulk weight	up to approx. 60 kg/m ³
Bale weight (depending on material)	up to approx. 480 kg
Cycle time	approx. 8.4-26.6 s / cycle
Strapping (fully automatic)	4-fold horizontal with wire

All technical data and dimensions are approximate values. Measurements in mm. Technical and design modifications reserved.



HSM VK 6215

- Versatile solution also for materials with bulk weights higher than 60 kg/m³
- Particularly suitable for compression of cardboard, plastic film, DSD goods, PET bottles and much more on request
- For continuous loading
- Large loading aperture (1500 x 970 mm) suitable for bulky material
- Option: HSM VK 6215 R suitable for residual waste (with wear-resistant steel)
- Available as an option with frequency controlled drive – saves 40 % of the energy used by standard drives

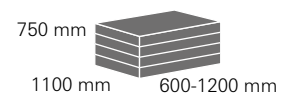
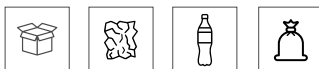

Model	HSM VK 6215
Pressing power	620 kN
Volume throughput	up to approx. 26.8 t / h with 50 kg/m ³
Bulk weight	> 60 kg/m ³ with 50 kg/m ³
Bale weight (depending on material)	up to approx. 550 kg
Cycle time	approx. 8.3-18.7 s / cycle
Strapping (fully automatic)	5-fold horizontal with wire

All technical data and dimensions are approximate values. Measurements in mm. Technical and design modifications reserved.



Throughput up to approx.
498 m³/h

HSM VK 7215

- Versatile system also for materials with bulk weights higher than 60 kg /m³
- For professional disposal management or larger industrial applications
- High throughput capacity
- For cardboard, paper, plastic film, DSD goods, PET bottles and much more on request
- For continuous loading
- 1500 mm loading aperture
- Option: HSM VK 7215 R suitable for residual waste (with wear-resistant steel)
- Available as an option with frequency controlled drive – saves 40 % of the energy used by standard drives

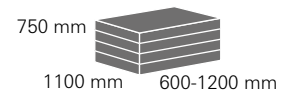

Model	HSM VK 7215
Pressing power	720 kN
Volume throughput	up to approx. 24.9 t / h with 50 kg/m ³
Bulk weight	> 60 kg/m ³
Bale weight (depending on material)	up to approx. 620 kg
Cycle time	approx. 8.9-13.2 s / cycle
Strapping (fully automatic)	5-fold horizontal with wire

All technical data and dimensions are approximate values. Measurements in mm. Technical and design modifications reserved.

HSM VK 6015

For industrial applications with special requirements



HSM VK 6015

- 4-fold strapping for optimised bale result
- Particularly suitable for cardboard, paper and plastic film and also for compressing DSD goods, PET bottles
- Also suitable for materials with bulk weights higher than 60 kg/m³
- Optimised bale dimensions and bale weights for efficient truck loading
- Large loading apertures, quick mode of operation
- Control of compression cycle via light barriers
- High compression and bale weights
- Available as an option with frequency controlled drive – saves 40 % of the energy used by standard drives



Processing industry



Department store



Document shredding industry



Printing and paper industry



**PET bottles/
USB disposal**



Disposal companies



Others



Throughput up to approx.
340 m³/h

HSM VK 6015

- Very high specific pressure – for high compaction
- High shearing force
- Versatile system also for materials with bulk weights higher than 60 kg/m³
- Particularly suitable for compression of paper, cardboard, plastic film, production remains, e.g. trimmings from a variety of materials
- For continuous loading
- Available as an option with frequency controlled drive – saves 40 % of the energy used by standard drives

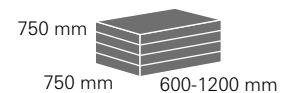

Model	HSM VK 6015
Pressing power	720 kN
Volume throughput	up to approx. 17 t / h with 50 kg/m ³
Bulk weight	> 60 kg/m ³
Bale weight (depending on material)	up to approx. 470 kg
Cycle time	approx. 8.9-23.7 s / cycle
Strapping (fully automatic)	4-fold horizontal with wire

All technical data and dimensions are approximate values. Measurements in mm. Technical and design modifications reserved.

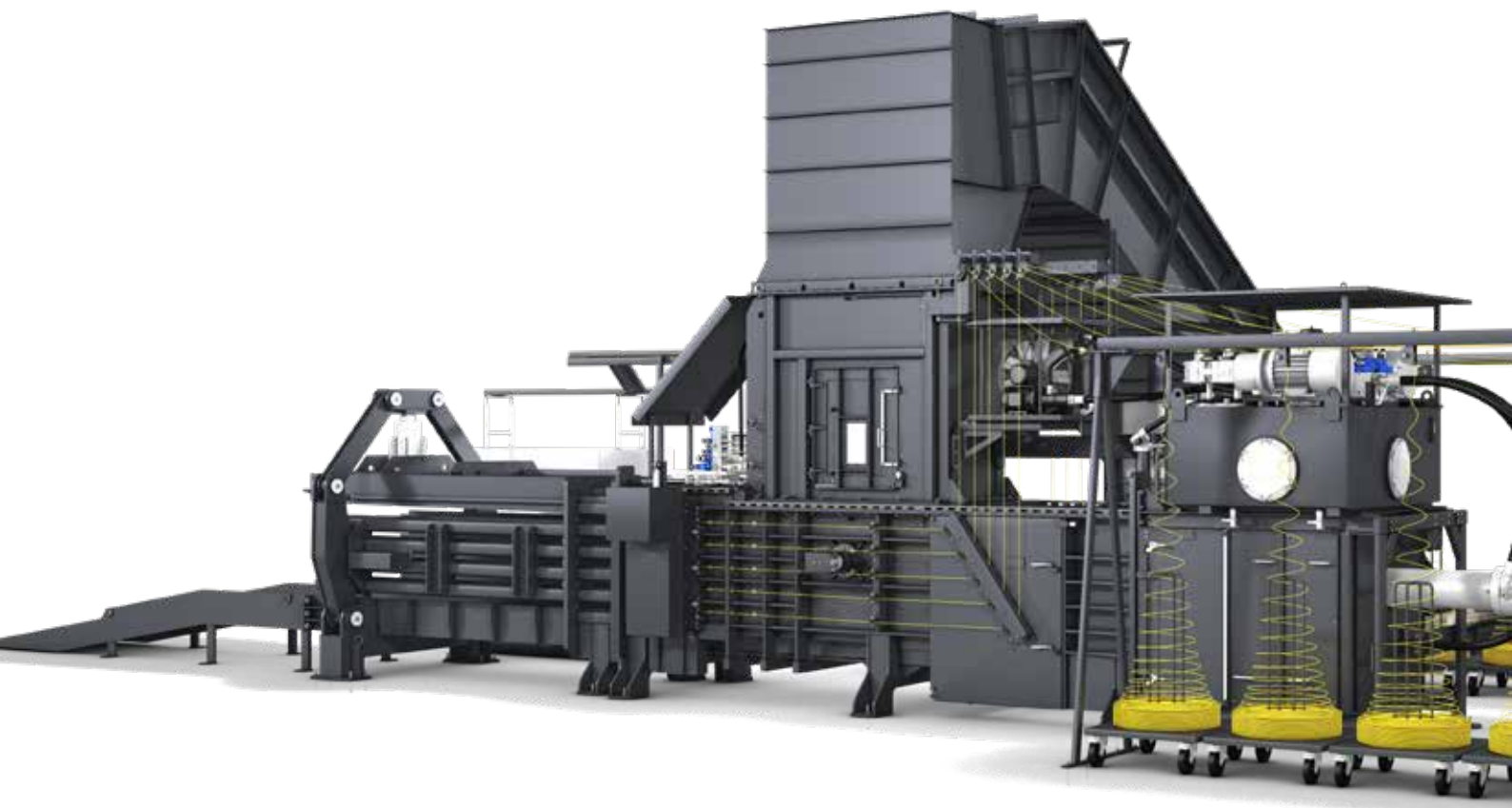

HSM VK 8818, VK 12018, VK 15020

For professional disposal management or major industrial applications

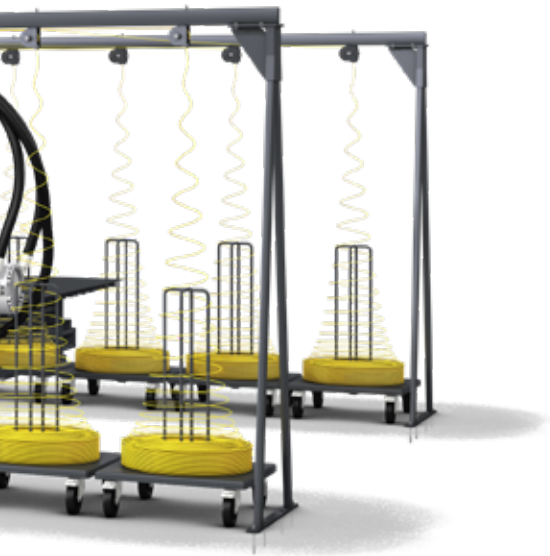

HSM VK 12018

- Versatile use, tried and tested many times
- Suitable for a wide variety of materials, e.g. cardboard, paper and plastic film, DSD goods, sorted residual waste and substitute fuels
- Also suitable for materials with bulk weights higher than 60 kg/m³
- Large loading apertures, fast mode of operation
- High bale weights, optimised bale sizes
- Very sturdy construction
- Control of compression cycle via light barriers
- For continuous operation with all standard conveyor and feeding facilities
- Available as an option with frequency controlled drive – saves 40 % of the energy used by standard drives



Printing and paper industry



Processing industry



**PET bottles/
UBC disposal**



Department stores



Disposal companies



Document shredding industry



Others



Throughput up to approx.
643 m³/h

HSM VK 8818

- High pressing power
- 5-fold strapping for optimal bale result with expansive materials
- Loading aperture 1000 x 1800 mm suitable for bulky material
- Versatile solution also for materials with bulk weights higher than 60 kg/m³
- Optimised bale dimensions and bale weights for efficient truck loading
- Option: HSM VK 8818 R suitable for residual waste (with wear-resistant steel)
- Available as an option with frequency-regulated drive – saves 40 % of the energy used by standard drives

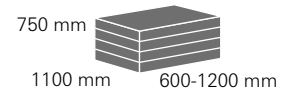

Model	HSM VK 8818
Pressing power	880 kN / 1000 kN
Volume throughput	up to approx. 32.1 t / h with 50 kg/m ³
Bulk weight	> 60 kg/m ³
Bale weight (depending on material)	up to approx. 800 kg
Cycle time	approx. 8.3-12.8 s / cycle
Strapping (fully automatic)	5-fold horizontal with wire

All technical data and dimensions are approximate values. Measurements in mm. Technical and design modifications reserved.



Throughput up to approx.
887 m³/h

HSM VK 12018

- Extremely high pressing power
- Optimised bale dimensions and bale weights for efficient truck loading
- Large loading aperture suitable for bulky material
- For large volumes
- 5-fold strapping for optimal bale result also with expansive materials
- For continuous operation with all standard conveyor and feeding facilities
- Solid steel construction with extremely wear-resistant, replaceable steel
- Easy access to all servicing parts via large inspection doors
- Modern control programme with touch screen
- Option: HSM VK 12018 R suitable for residual waste (with wear-resistant steel)
- Available as an option with frequency controlled drive – saves 40 % of the energy used by standard drives

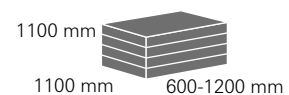

Model	HSM VK 12018
Pressing power	1200 kN
Volume throughput	up to approx. 44.4 t / h with 50 kg/m ³
Bulk weight	> 60 kg/m ³
Bale weight (depending on material)	up to approx. 1100 kg
Cycle time	approx. 8.8-15.5 s / cycle
Strapping (fully automatic)	5-fold horizontal with wire

All technical data and dimensions are approximate values. Measurements in mm. Technical and design modifications reserved.



HSM VK 15020

- Very high pressing power
- 5-fold strapping for optimal bale result with expansive materials
- Very large loading aperture suitable for bulky material
- Versatile solution also for materials with bulk weights higher than 60 kg/m³
- Optimised bale dimensions and bale weights for efficient truck loading
- Option: HSM VK 15020 R suitable for residual waste (with wear-resistant steel)
- Available as an option with frequency controlled drive – saves 40 % of the energy used by standard drives

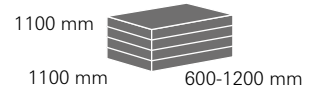

Model	HSM VK 15020
Pressing power	1500 kN
Volume throughput	up to approx. 43.6 t / h with 50 kg/m ³
Bulk weight	> 60 kg/m ³
Bale weight (depending on material)	up to approx. 1250 kg
Cycle time	approx. 10.0-15.6 s / cycle
Strapping (fully automatic)	5-fold horizontal with wire

All technical data and dimensions are approximate values. Measurements in mm. Technical and design modifications reserved.

HSM special technical solutions and optional features

Anything you need is possible: depending on the purpose and your individual requirements, other function modules can be added to each baling press. The modular system comes with the solution to

resolve disposal tasks in the best possible way. All models up to HSM VK 42 can also be equipped with manual strapping.



Shearing blade clearing device

Removes material jams in front of the shearing blade



Protective sound cover

Protects the driving unit against dirt and dust and reduces the noise level by up to 9 dB(A).



Feeding systems

Lifting/tilting systems, conveyor technology or suction systems for loading the baling press



Remote maintenance system

- For external communication and data transmission
- External monitoring of the machine via system and web-cam is possible for HSM and the customer
- Enables a long-term continuous machine operation, minimization of maintenance costs
- Usable as training device



Pre-Compactor

- For pre-compacting press material
- Prevents bridges in the loading shaft
- Optimises filling and throughput capacity



Frequency inverter

- Energy savings up to 40 % compared to the standard drive, process optimisation, energy-saving motor drive
- Available for HSM VK 6015, VK 6215, VK 7215, VK 8818, VK 12018, VK 15020



Perforator

PET-Perforator for versatile requirements and different feeding systems. Bulky PET- bottles are compressed to compact bales.

Other Options:

- Motors and pumps in many special voltages on request
- Control cabinet heatings at ambient temperatures of below 10 °C
- Tank heatings at ambient temperatures of below 4 °C
- Oil cooler for use during continuous operation or high ambient temperatures
- Extension of control system for multiple components with separate control panel in feeding area
- Less use of wire, thanks to the ability to switch off wire strappings manually
- Special paintwork in the colour of your choice
- Adaptation hopper for optimum connection to feeding conveyor, cyclone or similar
- Working hour meter
- Bale chute, bale discharge
- Acoustic or visual warning signals
- and much more

Proven overall quality: Sophisticated solutions in the smallest detail.

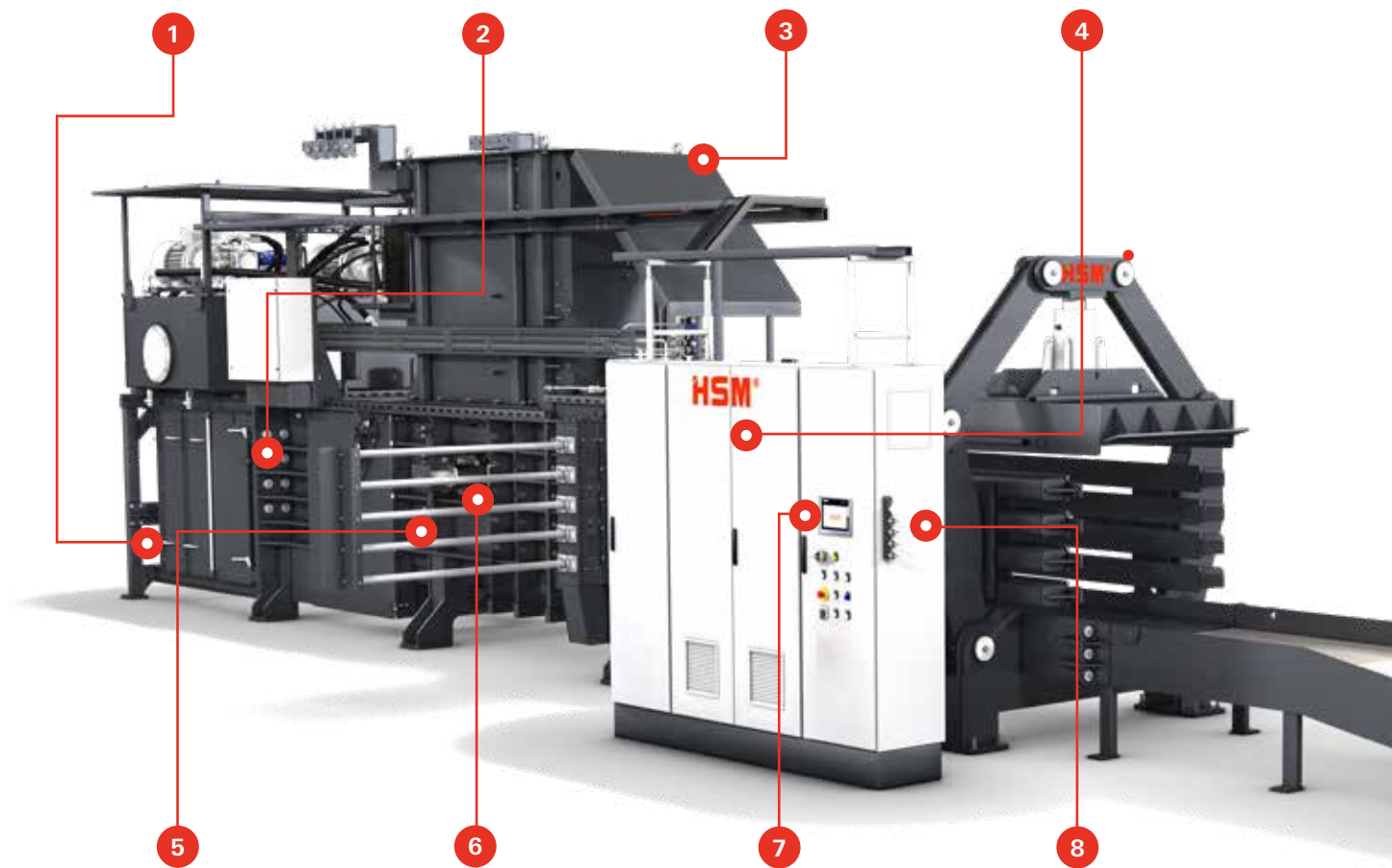
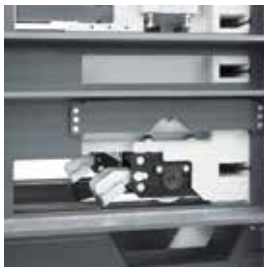

“The whole is more than the sum of its parts.” The combination of all detailed solutions means that each user reaps the maximum benefit. Longevity, economic efficiency, operator friendliness and durability – these are the typical benefits of each HSM baling press. A major argument for HSM balers is their economic efficiency during operation.

A lower consumption of oil and energy keeps servicing costs low. In particular, the use of oil filter systems paysoff quickly as the oil consumption is drastically reduced. These advantages turn each HSM baling press into an investment that is profitable over its entire service life.

1 Solid press carriage guidance with easy maintenance access

- Optimum self cleaning of the roller track
- Individually arranged, movable rail cleaners
- Very strong roller bearings
- Direct lubrication

2 Gimballed press cylinder system*/**

- Tension free mounted press cylinder
- Reduced wear on the pressing cylinder and press ram guides
- Longer service life of the hydraulic cylinder and other components

3 Wear-resistant steel

- Use of wear-resistant steel for highly stressed areas
- Double-walled design of pressing chamber and pressing channel ensures easy maintenance and replacement*
- Wear-resistant steel twisting fingers for a very long service life

4 Frequency controlled drive

- Energy savings of up to 40 % compared to the standard drive with unchanged performance
- Process optimisation
- Energy-saving motor and machine drive*
- Patented fully frequency controlled hydraulic drive concept
- Available as option*

5 Locking cylinder*

- Increases operational safety during wirestrapping e.g. if there is a power cut
- Prevents the press ram being pushed back during bale strapping if the emergency-stop is activated or there is a power cut
- Prevents bending of the wire insertion cylinder

6 Bale measurement system

- Determines the bale length exactly, even if the materials used are changed frequently

7 Display*

- High resolution 15" touch panel
- Easy to operate controls and clear baler display
- Integration of webcam views possible

8 Door safety lock system

- Key-operated inspection door safety lock system (Castle-lock) for highest level of operator safety*

9 Crosswise strapping

- Combination of vertical and horizontal strapping
- Optionally available for VK 15020 for the compression of small-particle plastics etc.



*not available for HSM VK 5012

**HSM VK 6215 without gimballed press cylinder system

Technical details at a glance:

Model	Main driving power in kW	Main driving power with FC in kW	Pressing power in kN	Specific pressing power in N/cm ³	Cycle time in idle operation (theor.) in sec.	Volume throughput in idle operation (theor.) in m ³ /h	Volume throughput at 20 kg/m ³ in t/h	Volume throughput at 50 kg/m ³ in t/h
HSM AK 807	4	-	82	32,8	17,6	36	0,72	-
HSM VK 807 V	4	-	82	32,8	23,2	28	0,55	-
HSM VK 1206	9,2	-	160	42,7	8,2	99	1,98	-
HSM VK 1210	9,2	-	160	42,7	11,5	117	2,35	-
HSM VK 2306	9,2	-	240	64,0	12,3	66	1,32	3,29
	15	-	240	64,0	6,7	121	2,42	6,04
HSM VK 2310	9,2	-	240	64,0	17,2	78	1,57	3,92
	15	-	240	64,0	9,4	144	2,87	7,18
HSM VK 3008	15	-	310	55,4	11,3	143	2,86	7,16
	22	-	310	55,4	8,2	197	3,93	9,83
HSM VK 3012	15	-	310	55,4	13,9	166	3,31	8,29
	22	-	310	55,4	10,1	228	4,55	11,38
HSM VK 4012	15	-	450	69,4	16,7	174	3,49	8,72
	22	-	450	69,4	12,2	239	4,79	11,97
HSM VK 4208	15	-	420	75,0	14,1	114	2,28	5,71
	22	-	420	75,0	10,3	157	3,13	7,83
	30	-	420	75,0	7,5	216	4,33	10,82
HSM VK 4212	15	-	420	75,0	17,4	132	2,64	6,61
	22	-	420	75,0	12,7	181	3,63	9,07
	30	-	420	75,0	9,2	251	5,01	12,53
HSM VK 4812	15	-	480	58,2	21,2	175	3,50	8,76
	22	-	480	58,2	15,4	240	4,81	12,02
	30	-	480	58,2	11,2	332	6,64	16,61
HSM VK 4812 V	15	-	480	58,2	24,5	151	3,03	7,57
	22	-	480	58,2	18,2	204	4,08	10,21
HSM VK 4812 P	15	-	480	58,2	24,5	151	3,03	7,57
	22	-	480	58,2	18,2	204	4,08	10,21
	15	-	500	60,6	26,6	178	3,57	8,92
HSM VK 5012	22	-	500	60,6	19,4	245	4,90	12,25
	30	-	500	60,6	14,0	338	6,77	16,92
	45	-	500	60,6	9,8	485	9,7	24,25
HSM VK 5016	15	-	500	60,6	26,6	178	3,57	8,92
	22	-	500	60,6	19,4	245	4,90	12,25
	30	-	500	60,6	14,0	338	6,77	16,92
	45	-	500	60,6	9,8	485	9,7	24,25
	30	-	720	128,0	23,7	128	2,57	6,41
HSM VK 6015	45	-	720	128,0	16,5	184	3,68	9,19
	55	45	720	128,0	13,2	231	4,62	11,55
	75	55	720	128,0	10,4	291	5,81	14,53
	90	75	720	128,0	8,9	340	6,80	16,99
HSM VK 6215	30	-	620	75,2	18,7	238	4,76	11,90
	45	-	620	75,2	13,1	341	6,82	17,06
	55	45	620	75,2	10,4	429	8,57	21,44
	75	55	620	75,2	8,3	540	10,79	26,98
HSM VK 7215	55	45	720	87,3	13,2	339	6,77	16,94
	75	55	720	87,3	10,4	426	8,52	21,31
	90	75	720	87,3	9,0	498	9,95	24,88
	90	75	880	106,7	12,8	417	8,34	20,85
HSM VK 8818	45+45	30+30	880	106,7	12,8	418	8,35	20,89
	55+55	45+45	880	106,7	8,3	571	11,42	28,56
	90	75	1000	121,2	12,8	417	8,34	20,85
	45+45	30+30	1000	121,2	12,8	418	8,35	20,88
	55+55	45+45	1000	121,2	8,3	571	11,42	28,56
HSM VK 12018	45+45	30+30	1200	99,2	15,5	506	10,12	25,31
	55+55	45+45	1200	99,2	10,0	692	13,84	34,61
	75+75	55+55	1200	99,2	8,8	837	16,74	41,86
HSM VK 15020	55+55	45+45	1500	124,0	15,6	557	11,14	27,86
	75+75	55+55	1500	124,0	11,4	767	15,34	38,35
	-	75+75	1500	124,0	10,0	873	17,45	43,64

All technical data and dimensions are approximate values. Measurements in mm. Technical and design modifications reserved.

Bale weight in kg with 1200 mm bale length	Bale size W x H x L in mm	Bale/channel cross-section W x H in mm	Strapping x-fold	Loading aperture W x L in mm	Loading volume in m ³	Tank capacity in l	Weight in t from	Model
30-60 (with 600 mm)	500 x 500 x var.	500 x 500	3	450 x 710	0,18	30	1,0	HSM AK 807
30-60 (with 600 mm)	500 x 500 x var.	500 x 500	2	450 x 710	0,18	30	1,0	HSM VK 807 V
100-200	750 x 500 x var.	750 x 500	3	670 x 600	0,23	123	3,4	HSM VK 1206
100-200	750 x 500 x var.	750 x 500	3	670 x 1000	0,38	123	3,8	HSM VK 1210
140-250	750 x 500 x var.	750 x 500	3	670 x 600	0,23	123	3,5	HSM VK 2306
140-250	750 x 500 x var.	750 x 500	3	670 x 600	0,23	300	3,9	
140-250	750 x 500 x var.	750 x 500	3	670 x 1000	0,38	123	3,8	HSM VK 2310
140-250	750 x 500 x var.	750 x 500	3	670 x 1000	0,38	300	4,3	
190-350	700 x 800 x var.	700 x 800	4	620 x 800	0,45	300	6,3	HSM VK 3008
190-350	700 x 800 x var.	700 x 800	4	620 x 800	0,45	300	6,3	
190-350	700 x 800 x var.	700 x 800	4	620 x 1140	0,64	300	6,3	HSM VK 3012
190-350	700 x 800 x var.	700 x 800	4	620 x 1140	0,64	300	6,3	
250-400	900 x 720 x var.	900 x 720	3	820 x 1250	0,81	300	7,0	HSM VK 4012
250-400	900 x 720 x var.	900 x 720	3	820 x 1250	0,81	300	7,0	
220-420	700 x 800 x var.	700 x 800	4	620 x 800	0,45	300	6,3	HSM VK 4208
220-420	700 x 800 x var.	700 x 800	4	620 x 800	0,45	300	6,3	
220-420	700 x 800 x var.	700 x 800	4	620 x 800	0,45	630	6,3	HSM VK 4212
220-420	700 x 800 x var.	700 x 800	4	620 x 1140	0,64	300	6,3	
220-420	700 x 800 x var.	700 x 800	4	620 x 1140	0,64	630	6,3	HSM VK 4812
300-450	1100 x 750 x var.	1100 x 750	4	1020 x 1250	1,03	300	10,0	
300-450	1100 x 750 x var.	1100 x 750	4	1020 x 1250	1,03	300	10,0	HSM VK 4812 V
300-450	1100 x 750x var.	1100 x 750	4	1020 x 1250	1,03	630	10,0	
300-450	1100 x 750 x var.	1100 x 750	4	1020 x 1250	1,03	300	10,0	HSM VK 4812 P
300-450	1100 x 750 x var.	1100 x 750	4	1020 x 1250	1,03	300	10,0	
300-480	1100 x 750 x var.	1100 x 750	4	1020 x 1250	1,03	300	17,5	HSM VK 5012
300-480	1100 x 750 x var.	1100 x 750	4	1020 x 1250	1,03	630	17,5	
300-480	1100 x 750 x var.	1100 x 750	4	1020 x 1600	1,03	300	17,5	HSM VK 5016
300-480	1100 x 750 x var.	1100 x 750	4	1020 x 1600	1,03	630	17,5	
300-480	1100 x 750 x var.	1100 x 750	4	1020 x 1600	1,03	630	17,5	HSM VK 6015
260-470	750 x 750 x var.	750 x 750	4	620 x 1500	0,84	630	24,0	
260-470	750 x 750 x var.	750 x 750	4	620 x 1500	0,84	1250	24,0	HSM VK 6215
260-470	750 x 750 x var.	750 x 750	4	620 x 1500	0,84	1250	24,0	
300-550	1100 x 750 x var.	1100 x 750	5	970 x 1500	1,24	630	23,0	HSM VK 7215
300-550	1100 x 750 x var.	1100 x 750	5	970 x 1500	1,24	1250	23,0	
340-620	1100 x 750 x var.	1100 x 750	5	970 x 1500	1,24	1250	24,0	HSM VK 8818
340-620	1100 x 750 x var.	1100 x 750	5	970 x 1500	1,24	2000 (1250)	24,0	
500-700	1100 x 750 x var.	1100 x 750	5	970 x 1800	1,49	2000 (1250)	33,0	HSM VK 12018
500-700	1100 x 750 x var.	1100 x 750	5	970 x 1800	1,49	2000	33,0	
500-700	1100 x 750 x var.	1100 x 750	5	970 x 1800	1,49	3000 (2000)	33,0	HSM VK 15020
550-800	1100 x 750 x var.	1100 x 750	5	970 x 1800	1,49	2000 (1250)	33,0	
550-800	1100 x 750 x var.	1100 x 750	5	970 x 1800	1,49	2000	33,0	HSM VK 15020
550-800	1100 x 750 x var.	1100 x 750	5	970 x 1800	1,49	3000 (2000)	33,0	
700-1100	1100 x 1100 x var.	1100 x 1100	5	970 x 1800	2,18	2000	38,0	HSM VK 15020
700-1100	1100 x 1100 x var.	1100 x 1100	5	970 x 1800	2,18	3000 (2000)	38,0	
700-1100	1100 x 1100 x var.	1100 x 1100	5	970 x 1800	2,18	3000	38,0	HSM VK 15020
800-1250	1100 x 1100 x var.	1100 x 1100	5	970 x 2000	2,42	3000 (2000)	45,0	
800-1250	1100 x 1100 x var.	1100 x 1100	5	970 x 2000	2,42	3000	45,0	HSM VK 15020
800-1250	1100 x 1100 x var.	1100 x 1100	5	970 x 2000	2,42	3000	45,0	

Model dimensions in mm:

Model	Overall length	Overall width	Press channel width (interior dimension)	Press channel height (interior dimension)	Loading hopper length (cubic, interior dimension)	Loading hopper width (cubic, interior dimension)	Loading hopper overall height (cubic)	Wire insertion cylinder width to centre of baling press (cubic)	Twisting unit width to centre of baling press
	L	B	O	P	E	S	H	X	Y
HSM AK 807	3940	1140	500	500	710	450	1400	-	-
HSM VK 807 V	4813	1188	500	500	710	450	2281	-	-
HSM VK 1206	4795	2863	750	500	600	670	1565	1849	1014
HSM VK 1210	5594	2863	750	500	1000	670	1940	1849	1014
HSM VK 2306	5295	2863	750	500	600	670	1565	1849	1050
HSM VK 2310	6095	2863	750	500	1000	670	1940	1849	1050
HSM VK 3008	6498	2951	700	800	800	620	2030	1700	900
HSM VK 3012	7378	2951	700	800	1140	620	2465	1700	900
HSM VK 4012	7043	3163	900	720	1250	820	2350	2090	1126
HSM VK 4208	6960	2882	700	800	800	620	2030	1700	900
HSM VK 4212	7378	2882	700	800	1140	620	2030	1700	900
HSM VK 4812	7530	3742	1100	750	1250	1020	2400	2520	1230
HSM VK 4812 V	7456	2570	1100	748	1250	1020	2583	-	1210
HSM VK 4812 P	6661	3994	1100	748	1250	1020	2583	2660	1210
HSM VK 5012	8861	3994	1100	750	1250	1020	3000	2640	1361
HSM VK 5016	9682	3994	1100	750	1250	1060	3000	2640	1361
HSM VK 6015	10683	3664	750	750	1500	620	3260	2582	1187
HSM VK 6215	10578	4159	1100	750	1500	970	3260	2757	1362
HSM VK 7215	10750	4159	1100	750	1500	970	3260	2757	1362
HSM VK 8818	12272	4159	1100	750	1800	970	3270	2782	1377
HSM VK 12018	12413	4159	1100	1100	1800	970	3622	2782	1377
HSM VK 15020	13115	4159	1100	1100	2000	970	3622	2782	1377

All technical data and dimensions are approximate values. Measurements in mm. Technical and design modifications reserved.

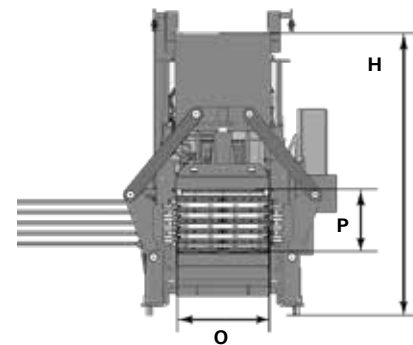
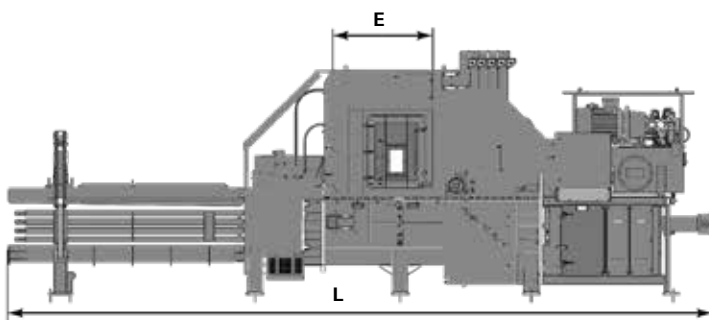
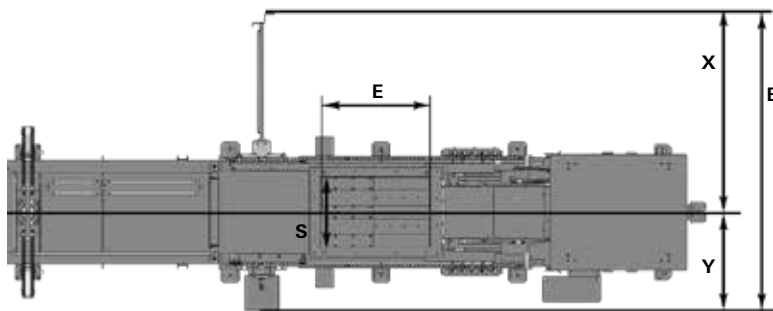

L	Overall length	S	Loading hopper width, cubic, interior dimension
B	Overall width	H	Loading hopper overall height, cubic
O	Press channel width, interior dimension	X	Wire insertion cylinder width to centre of baling press
P	Press channel height, interior dimension	Y	Twisting unit width to centre of baling press
E	Loading hopper length, cubic, interior dimension		

Explanations of the technical data:

• Main driving power	Rated power of baler driving motor without additional aggregates (e.g. oil cooler).
• FC	Frequency controlled drive
• Pressing power	Cylinder piston surface multiplied with the maximum hydraulic pressure (theoretical value).
• Specific pressing power	Force in N acting on 1 cm ² of the material to be compressed.
• Cycle time in idle operation (theor.)	The time it takes for the press ram to move forward without material and return idling to the home position. The pressing time does not depend on material.
• Volume throughput in idle operation	The maximum volume that can be theoretically pressed in one hour without interruption of the pressing procedure (theor.) for loading or strapping. It is calculated by dividing the press chamber volume by the pressing time.
• Volume throughput at 20/50 kg/m ³	The maximum weight that can be theoretically pressed in one hour at a bulk weight of 20/50 kg/m ³ without interruption of the pressing procedure for loading or strapping.
• Practical volume throughput	The practical volume throughput is up to 70 % of the theoretical volume throughput and depends on the loading method, the bulk weight, the type of material and control delays.
• Bale weight	Bale weight varies depending on the type, humidity and condition of the compressed material and on bale length/ height. Bale weight with 1200 mm length (deviating bale length in brackets).
• Bale size	The height/length of the bales varies depending on the expansion force of the compressed material. With channel baling presses the bale length can be set variably within the specified limits.
• Bale / channel cross-section	Width x height of bale or of press channel.
• Strapping	Information concerning the number of times the bales are strapped.
• Loading aperture	Size of the opening through which material can be loaded.
• Loading volume	Loading aperture x height of press chamber.
• Tank capacity	Volume of hydraulic oil tank in litres.
• Weight	Net weight of machine without packaging, loaded material, feeding system or options.
• Voltage / frequency	Three-phase current power supply, 3 x 400 V / 50 Hz.
• Bulk weight	Weight of the loaded material per cubic meter. The bulk weight affects the volume throughput.
• Throughput capacity	Max. amount (weight/volume) that can be theoretically processed in one hour.

HSM product portfolio for specialist solutions:



Vertical baling presses

HSM V-Press – compact waste management solutions.

HSM Barrel press – compaction of light metal and rolled hoop barrels.



Horizontal baling presses

HSM Horizontal baling press – large loading aperture and low overall height. Suitable for different materials such as paper, cardboard, plastic films, expanding foams, polystyrene, hollow vessels, metal buckets, barrels, car tyres and much more.

HSM – the company

Shredding and Compressing.



Since 1971, HSM has been pursuing a clear strategy – a consistent commitment to quality “Made in Germany”. This product and service quality is the key to success in both the office technology and environmental technology business sectors. As a specialist for products and services for data protection as well as technologies for optimising logistics and recycling processes, HSM is one of the world’s leading providers.

Enquire now! We are always glad to help.

Head office in Germany:

HSM GmbH + Co. KG · Austraße 1-9 · 88699 Frickingen / Germany
Tel. +49 7554 2100-0 · Fax +49 7554 2100-160
info@hsm.eu · www.hsm.eu

E-Mail / hotline:

Gratis Hotline
DE, AT, IT, ES, BE, NL, LU
Tel. 00800 44 77 77 66

HSM Vertrieb Deutschland
deutschland@hsm.eu

HSM Vertrieb Österreich
austria@hsm.eu

HSM Vertrieb Schweiz
schweiz@hsm.eu

HSM Verkoop België, Nederland,
Luxemburg
benelux@hsm.eu

HSM Commerciale Italia
italia@hsm.eu

HSM Ventas Portugal
iberia@hsm.eu

HSM subsidiaries:

HSM Técnica de Oficina y
Medioambiente España, S.L.U.
Calle de José Echegaray, 10
28100 Alcobendas, Madrid
Spain
Tel. +34 91 103 4859
Fax +34 91 103 4858
iberia@hsm.eu
www.hsm.eu

HSM France SAS
Parc de Genève
240, Rue Ferdinand Perrier
69800 Saint-Priest
France
Tél. +33 472 210580
Fax +33 472 517481
france@hsm.eu
www.hsm.eu

HSM (UK) Ltd.
14 Attwood Road / Zone 1
Burntwood Business Park
Burntwood · Staffordshire
WS7 3GJ
United Kingdom
Tel. +44 1543 272-480
Fax +44 1543 272-080
sales.uk@hsm.eu
www.hsm.eu

HSM Polska Sp. z o.o.
ul. Emaliowa 28
02-295 Warszawa
Poland
Tel. +48 22 8622369
Fax +48 22 8622368
handlowy@hsm.eu
www.hsm.eu

HSM of America LLC
419 Boot Road
Downingtown, PA 19335
USA
Tel. +1 484 237-2308
+1 800 613-2110
Fax +1 484 237-2309
customerservice@hsm.us
info@hsm.us
www.hsm.us

HSM China Ltd.
Room 504, Building C
Hangcheng Guangchang
Nanfaxin Town
Shunyi District
Beijing, PRC, 101300
China
Tel. +86 10 61429168
Fax +86 10 61429169
info@hsm-china.cn
www.hsm-china.cn